

# PergoLine Eco Shell





# PergoLine Eco Shell



Dimensions in mm Boyutlar mm

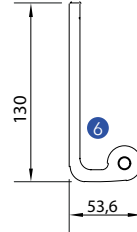
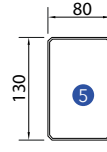
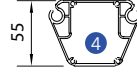
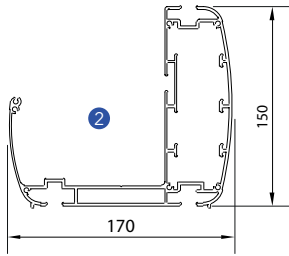
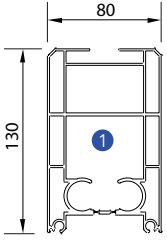
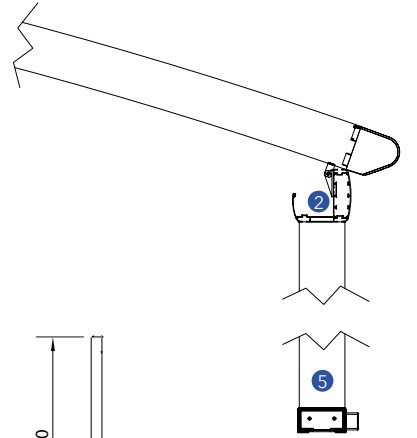
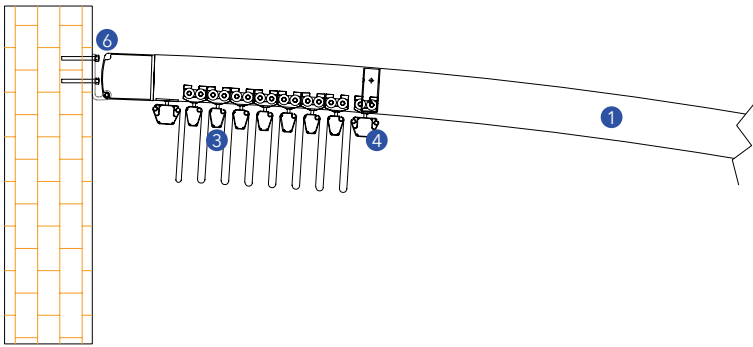

Frontal view / Önden görünüş

Side view / Yandan görünüş

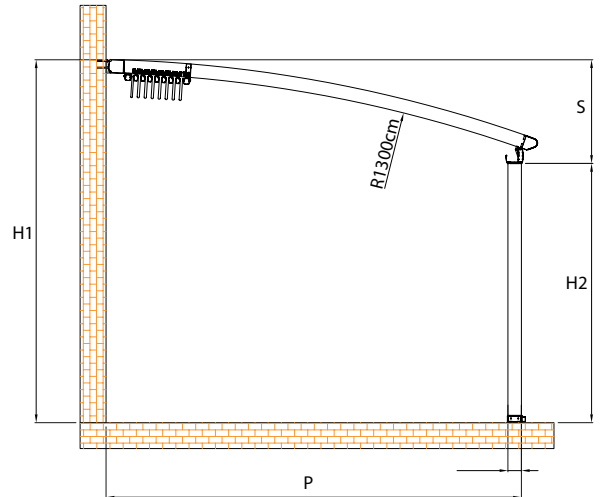
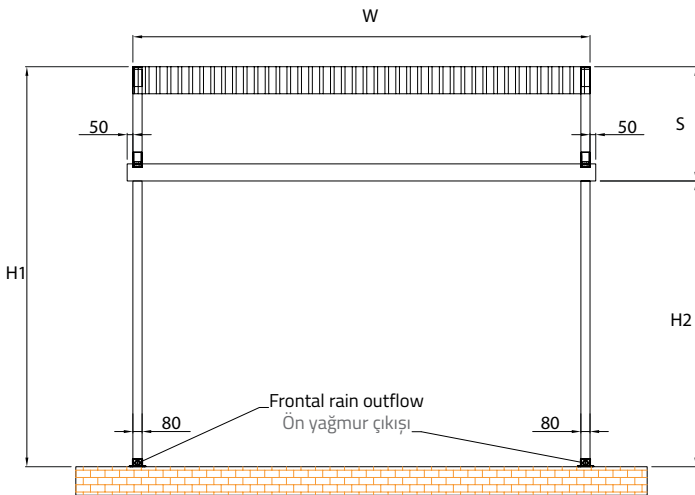



	Max. width	Max. projection
Single Form	450 cm	900 cm
Double Form	800 cm	900 cm
Triple Form	1200 cm	900 cm

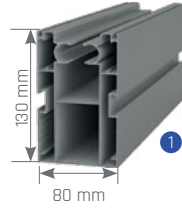

Rails

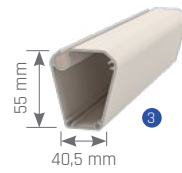
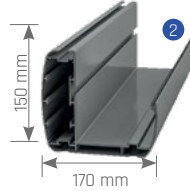

Fabric Profile

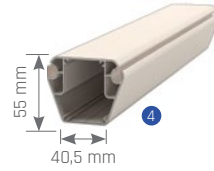

Fabric Profile

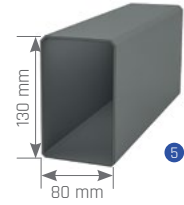

Pole

Extruded Frontal Gutter (Water-drain)

### Technical Details Teknik Ayrıntılar

System has 15% inclination for better water drain. If this structure doesn't have these following features, Byart Group will not be responsible for possible knapsacks of water or similar problems concerning the running-off of rainwater. Flowing profiles number is indicative, inclinations are the least guaranteed for a correct outflow of rainwater. For inferior inclinations to least measures pointed in the table, it is possible to add one or more intermediary rails, except for technical office approval.

İyi bir su tahliyesi için en az %15 eğim olmalı. Eğer bu yapı aşağıda belirtilen özelliklere sahip değilse Byart Group yağmur oluklarından veya yağmur suyunun akmasından kaynaklanan benzer sorunlardan sorumlu olmayacaktır. Yağmur suyunun doğru yere akması için doğru eğimin verilmesi şarttır, bunun da belirleyicisi raylardır. Tabloda belirtilen en düşük ölçülere yönelik daha az eğimler için teknik ofis onayı doğrultusunda bir veya birden fazla ara ray eklenmesi mümkündür.

### Anti -Wind profile / Rüzgar önleyici profil

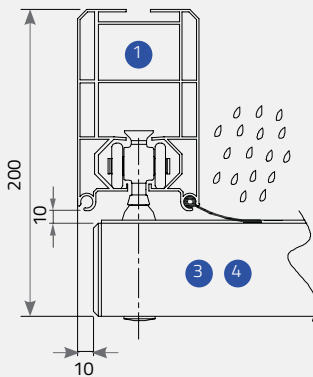

### Connection roof / Bağlantı çatısı

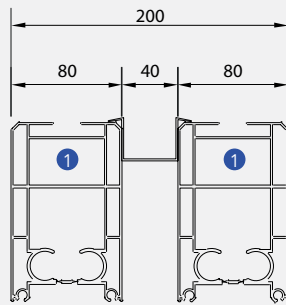

### Foot / Ayak

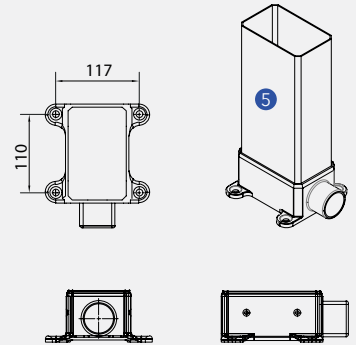

### Roof for cassette / Çatı Kaset

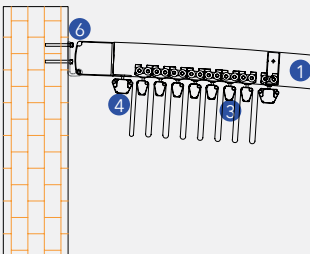

### Wall application bracket / Duvar uygulama köşebendi

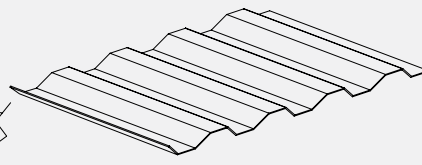

### Wall application bracket / Duvar uygulama köşebendi

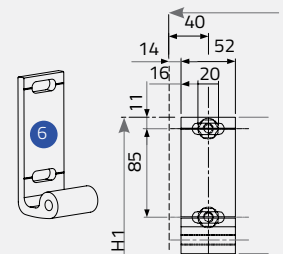

### Technical Legend / Teknik Tanım

- 1 Rail Ray
- 2 Extruded frontal water-drain Haddeden çekilmiş ön su tahliyesi
- 3 Middle flowing profile Orta akış profili
- 4 Last flowing profile Son akış profili
- 5 Pole Direk
- 6 Wall application bracket Duvar uygulama köşebendi

- H1 Back Height Arka Yükseklik
- H2 Frontal Height Ön Yükseklik
- P Projection Açıklım
- S Eğim Inclination
- W Width Genişlik
- X Packing Paketleme

# PergoLine Eco Shell

## Single Form / Tekli Form

Single form with 2 frontal poles + 1 motor remote control.  
2 ön direkli tekli form +1 motor uzaktan kumanda.

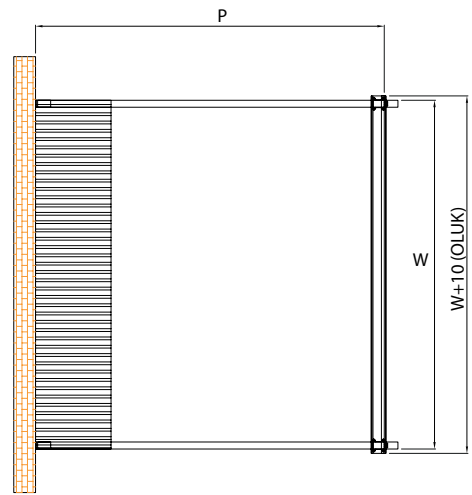
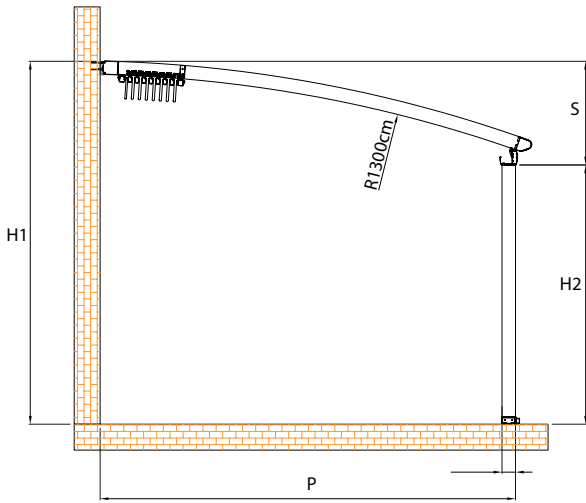

## COLORS RENKLER

9016 1013 8017 9005 9006 7043 7016



Other Colors +10%  
Diğer Renkler +%10

## Double Form / İkili Form

Double form with 3 frontal poles +2 motor and control unit.  
3 ön direkli ikili form +2 motor ve kontrol ünitesi.

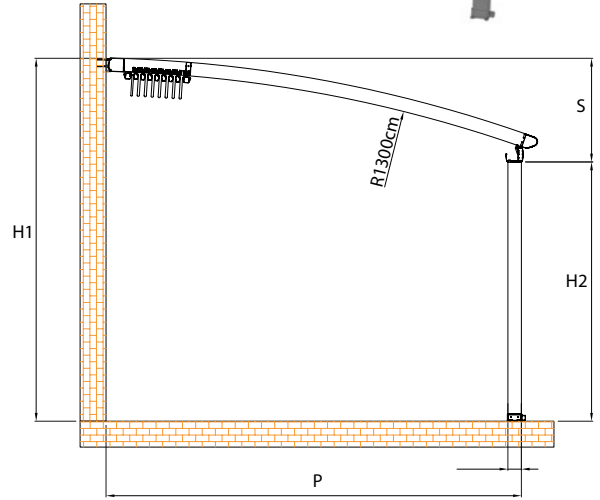
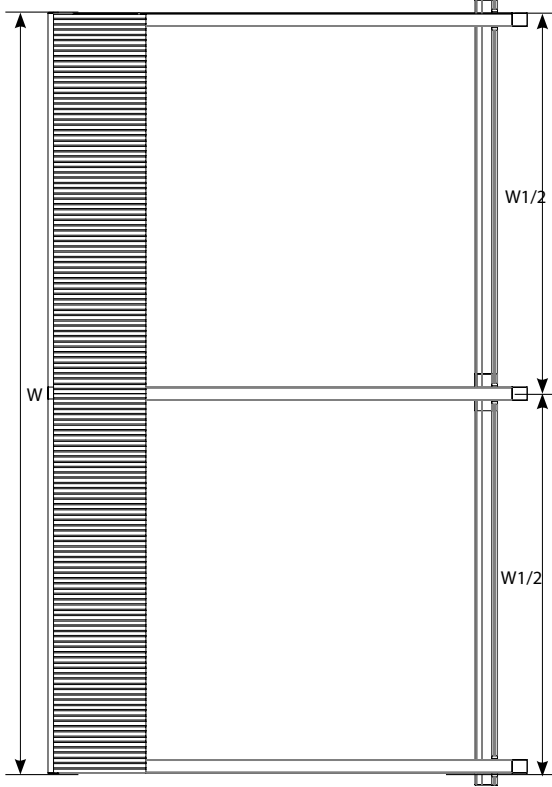

### COLORS RENKLER

9016 1013 8017 9005 9006 7043 7016



Other Colors +10%  
Diğer Renkler +%10

# PergoLine Eco Shell

## Triple Form / Üçlü Form

Triple form with 4 frontal poles +2 motor and control unit.  
4 ön direkli üçlü form + 2 motor ve kontrol ünitesi.

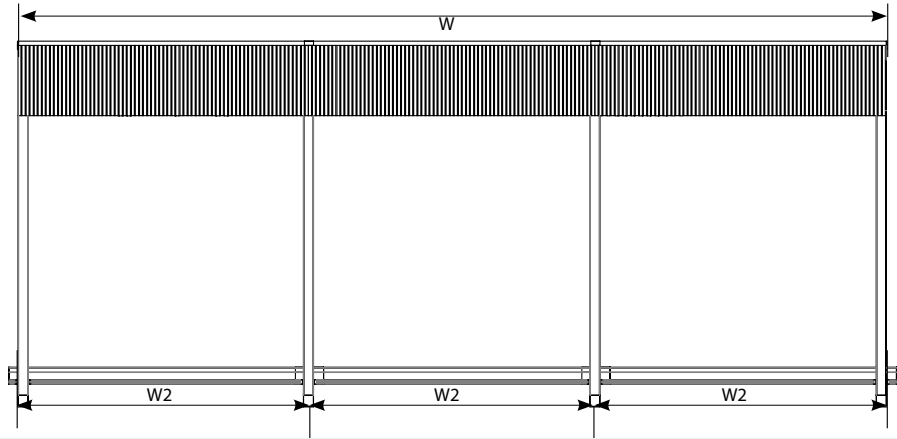
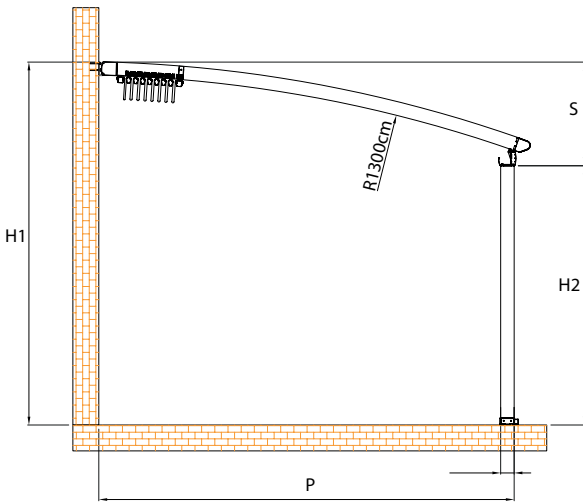

## COLORS RENKLER

9016 1013 8017 9005 9006 7043 7016



Other Colors +10%  
Diğer Renkler +%10

